

ULTRATUBE ULN_SG

EN 1004-1:2020

EN 1004-2:2021



202507-IU-1214

 **ULTRATUBE**

TR	Kullanım Kılavuzu
EN	User Manual
RU	Руководство пользователя
FR	Manuel de l'Utilisateur
DE	Benutzerhandbuch
ES	Manual de usuario

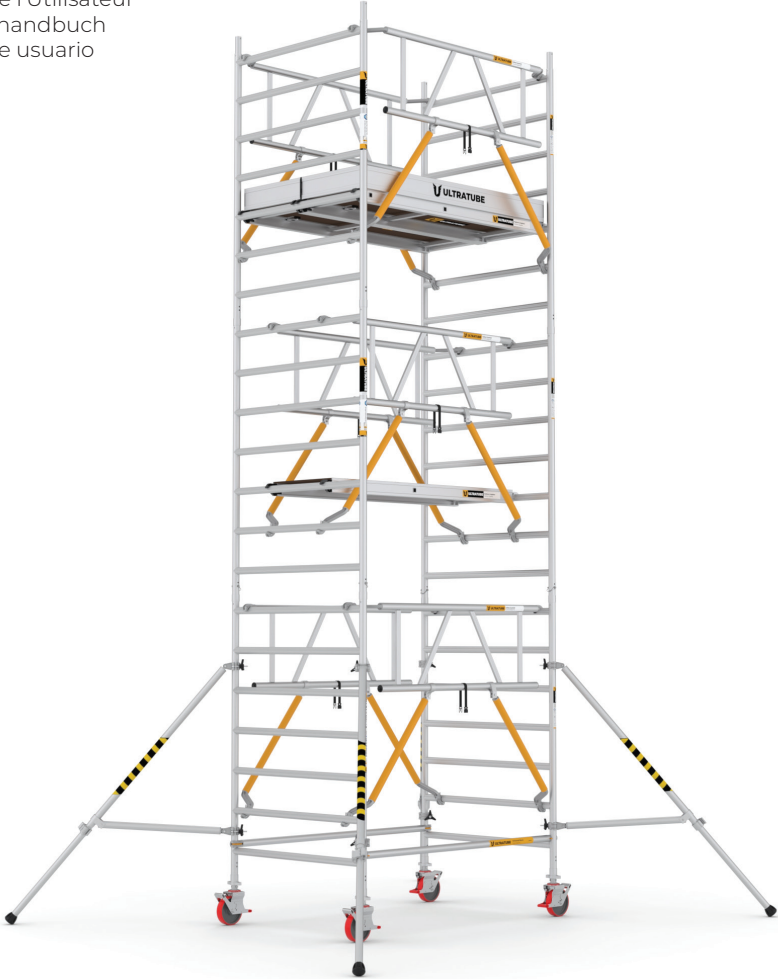

 **CAGSAN**

EN 1004

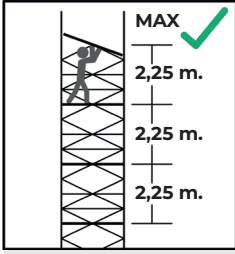

F. 1

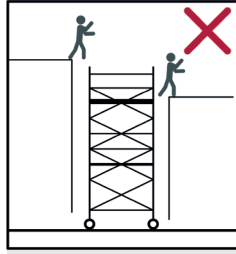

F. 2

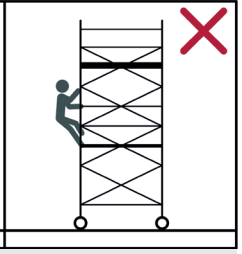
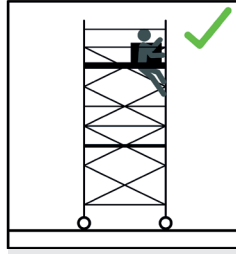

F. 3



F. 4

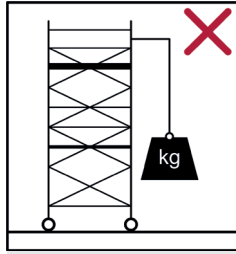

F. 5

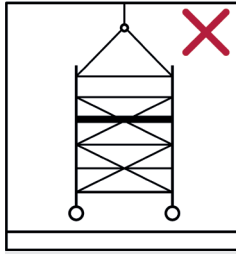

F. 6

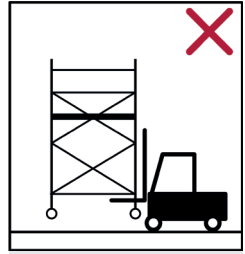

F. 7

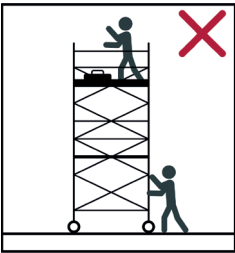

F. 8

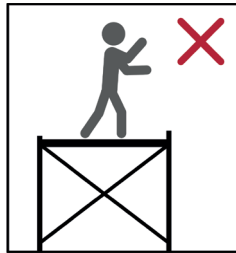

F. 9

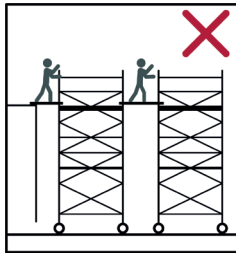

F. 10

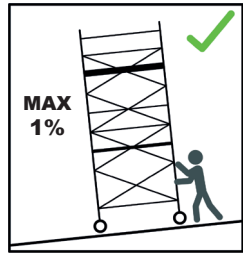

F. 11

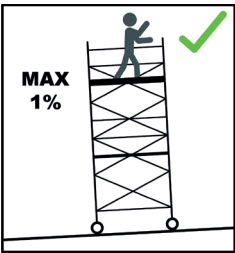

F. 12

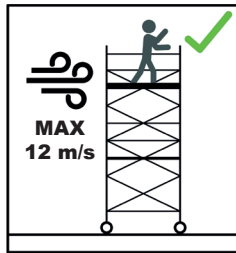

F. 13

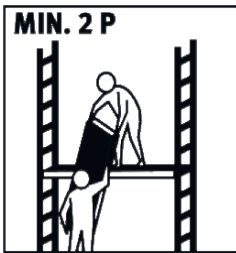



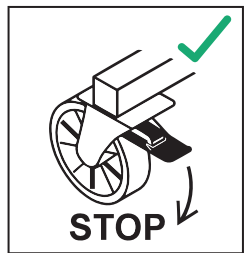





F. 14

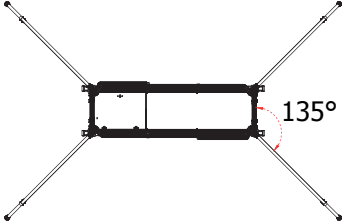
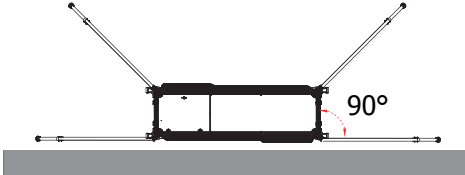
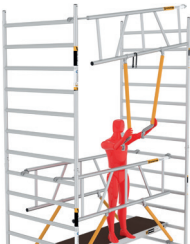

F. 15

EN 1004

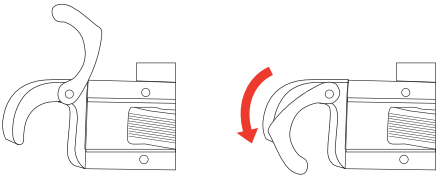
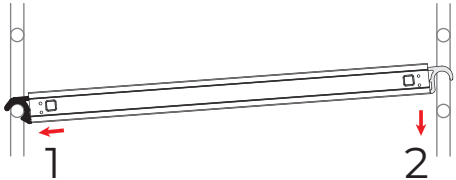
 <p>F. 14</p>	 <p>F. 15</p>	 <p>F. 16</p>	 <p>F. 17</p>
 <p>F. 19</p>	 <p>F. 20</p>		
 <p>F. 21</p>	 <p>F. 22</p>	 <p>F. 23</p>	 <p>F. 24</p>
<p>(180)</p>  <p>F. 25</p>	<p>(240)</p>  <p>F. 26</p>		

ULTRATUBE ULN505_SG(180)

1 PT200TE

2 UP0113570

3 UP0419000

4 UP0619000

5 UP0113570



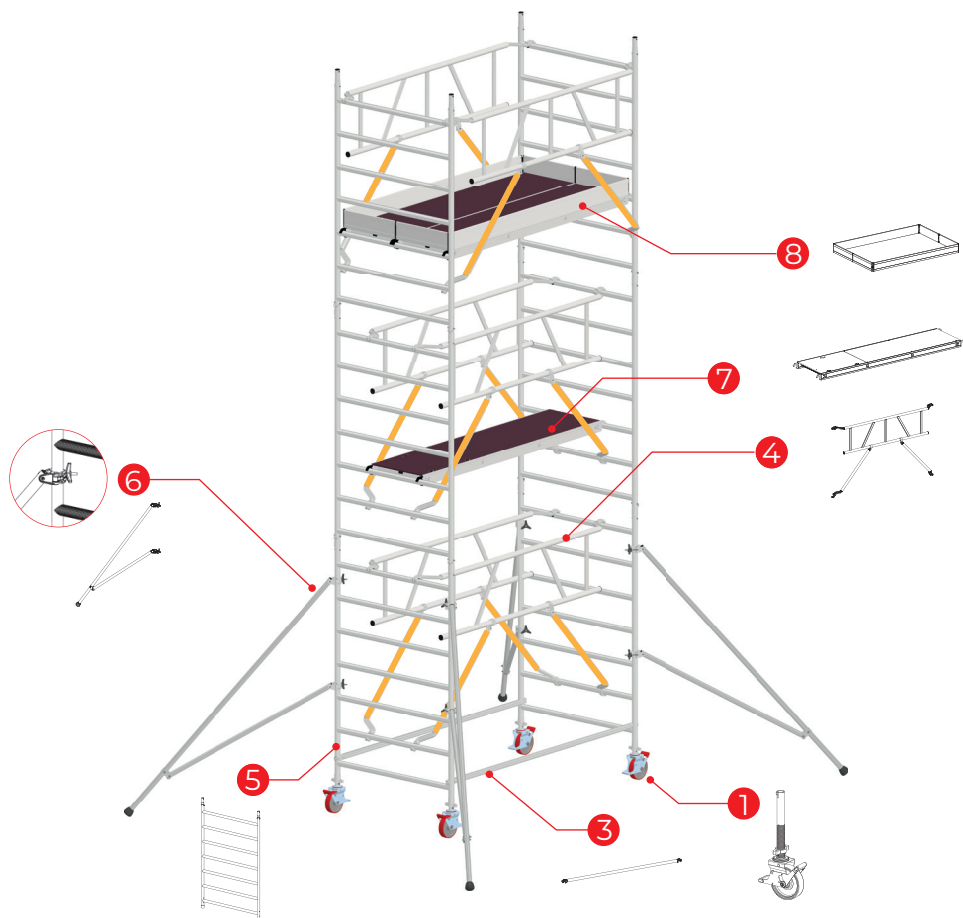

6 UP0723000

7 UP05190100



8 UP1019013500

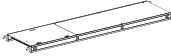



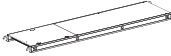
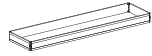

ULTRATUBE ULN_SG_(180)

			
<p>UP0619000</p> <p>TR Güvenli Korkuluk EN Safe Guardrail RU Ограждение безопасности FR Garde-corps sûr DE Sichere Leitplanke ES Barandilla de seguridad</p>	<p>UP0419000</p> <p>TR Yatay bağlantı EN Horizontal braces RU Горизонтальные распорки FR Croisillon Horizontaux DE Horizontale Klammern ES Tirantes horizontales</p>	<p>UP05190100</p> <p>TR Platform EN Platform RU Платформа FR Plate-forme DE Plattform ES Plataforma</p>	<p>UP1019013500</p> <p>TR Tekmelik EN Toeboard RU Бортик FR Plinthe DE Fußbrett ES Rodapié</p>

ULTRATUBE ULN_SG_(240cm)

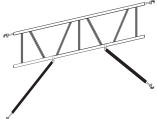
			
<p>UP0625000</p> <p>TR Güvenli Korkuluk EN Safe Guardrail RU Ограждение безопасности FR Garde-corps sûr DE Sichere Leitplanke ES Barandilla de seguridad</p>	<p>UP0425000</p> <p>TR Yatay bağlantı EN Horizontal braces RU Горизонтальные распорки FR Croisillon Horizontaux DE Horizontale Klammern ES Tirantes horizontales</p>	<p>UP05250100</p> <p>TR Platform EN Platform RU Платформа FR Plate-forme DE Plattform ES Plataforma</p>	<p>UP1025007500</p> <p>TR Tekmelik (PTS302TM) EN Toeboard RU Бортик FR Plinthe DE Fußbrett ES Rodapié</p>

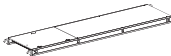
ULTRATUBE ULN_SG_(300cm)

			
<p>UP0625000</p> <p>TR Güvenli Korkuluk EN Safe Guardrail RU Ограждение безопасности FR Garde-corps sûr DE Sichere Leitplanke ES Barandilla de seguridad</p>	<p>UP0430500</p> <p>TR Yatay bağlantı EN Horizontal braces RU Горизонтальные распорки FR Croisillon Horizontaux DE Horizontale Klammern ES Tirantes horizontales</p>	<p>UP05305100</p> <p>TR Platform EN Platform RU Платформа FR Plate-forme DE Plattform ES Plataforma</p>	<p>UP1030507500</p> <p>TR Tekmelik EN Toeboard RU Бортик FR Plinthe DE Fußbrett ES Rodapié</p>

ULTRATUBE ULN_SG (180cm)

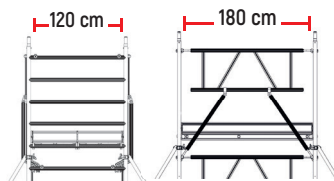

		ULN225 SG_(180)	ULN310 SG_(180)	ULN420 SG_(180)	ULN505 SG_(180)	ULN615 SG_(180)	ULN700 SG_(180)	ULN810 SG_(180)	ULN895 SG_(180)	ULN1000 SG_(180)	ULN1090 SG_(180)	ULN1205 SG_(180)
		a										
		b										
kg												
5,7	PT200TE 280x649x125mm.		4	4	4	4	4	4	4	4	4	4
6,2	UP0113540 1340x1245x51mm.		2	-	2	-	2	-	2	-	2	-
1,8	UP0419000 1999x50x50mm.		2	2	2	2	2	2	2	2	2	2
7,2	UP0619000 1886x160x80mm.		4	4	6	6	8	8	10	10	12	12
10,4	UP0113570 1340x2085x51mm.		2	4	4	6	6	8	8	10	10	12
5,7	UP0723000 1800x160x160mm.		4	4	4	4	4	4	4	4	4	4
15,9	UP05190100 1986x600x100mm.		2	2	3	3	4	4	5	5	6	6
9,2	UP1019013500 1886x160x80mm.		1	1	1	1	1	1	1	1	1	1
TOTAL KG			155	164	208	216	260	269	313	321	365	374

ULTRATUBE ULN_SG (240cm)

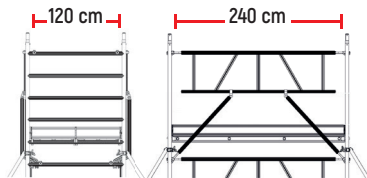

		ULN225 SG_(240)	ULN310 SG_(240)	ULN420 SG_(240)	ULN505 SG_(240)	ULN615 SG_(240)	ULN700 SG_(240)	ULN810 SG_(240)	ULN895 SG_(240)	ULN1000 SG_(240)	ULN1090 SG_(240)	ULN1205 SG_(240)
a		2,2m.	3,1m.	4,2m.	5,0m.	6,1m.	7,0m.	8,1m.	8,9m.	10,0m.	10,9m.	12,0m.
b		4,2m.	5,1m.	6,2m.	7,0m.	8,1m.	9,0m.	10,1m.	10,9m.	12,0m.	12,9m.	14,0m.
kg												
5,7	PT200TE 282x649x125mm. 	4	4	4	4	4	4	4	4	4	4	4
6,2	UP0113540 1350x1327x50mm. 	2	-	2	-	2	-	2	-	2	-	2
1,8	UP0425000 2588x50x50mm. 	2	2	2	2	2	2	2	2	2	2	2
8,4	UP0625000 2588x750x250. 	4	4	6	6	8	8	10	10	12	12	14
9,7	UP0113570 1350x2234x50mm. 	2	4	4	6	6	8	8	10	10	12	12
5,7	UP0113570 1800x160x160mm. 	4	4	4	4	4	4	4	4	4	4	4
21,4	UP05250100 2577x600x100mm. 	2	2	3	3	4	4	5	5	6	6	7
10,6	UP1025013500 2479x160x80. 	1	1	1	1	1	1	1	1	1	1	1
TOTAL KG		171	179	230	238	289	297	348	356	407	415	466

ULTRATUBE ULN_SG

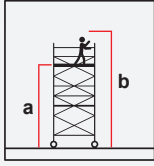

ULN225 ULN420 ULN615 ULN810 ULN1000 ULN1205

a	2,2m.	4,2m.	6,1m.	8,1m.	10,0m.	12,0m.
b	4,2m.	6,2m.	8,1m.	10,1m.	12,0m.	14,0m.

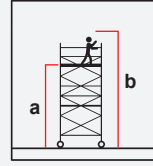

ULN310 ULN505 ULN700 ULN895 ULN1090

a	3,1m.	5,0m.	7,0m.	8,9m.	10,9m.
b	5,1m.	7,0m.	9,0m.	10,9m.	12,9m.

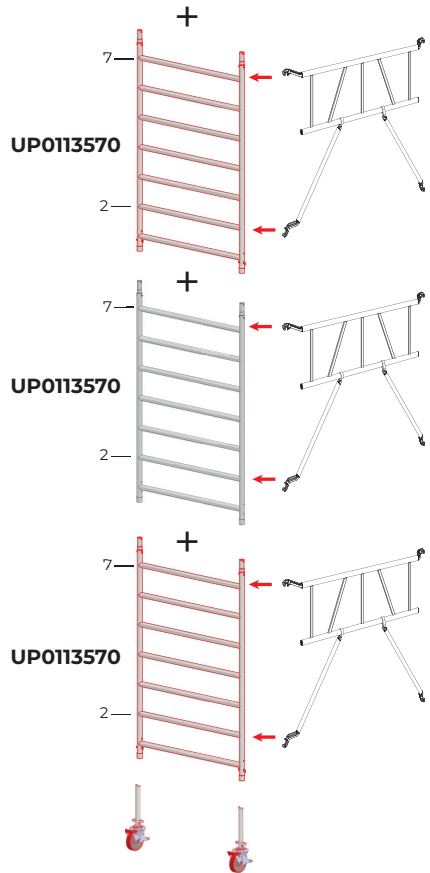
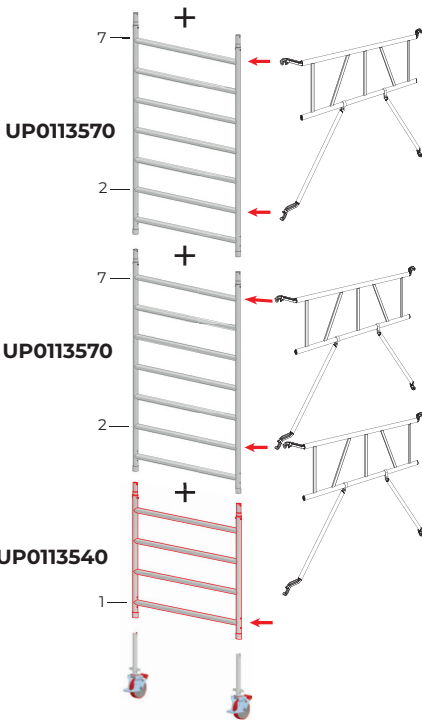

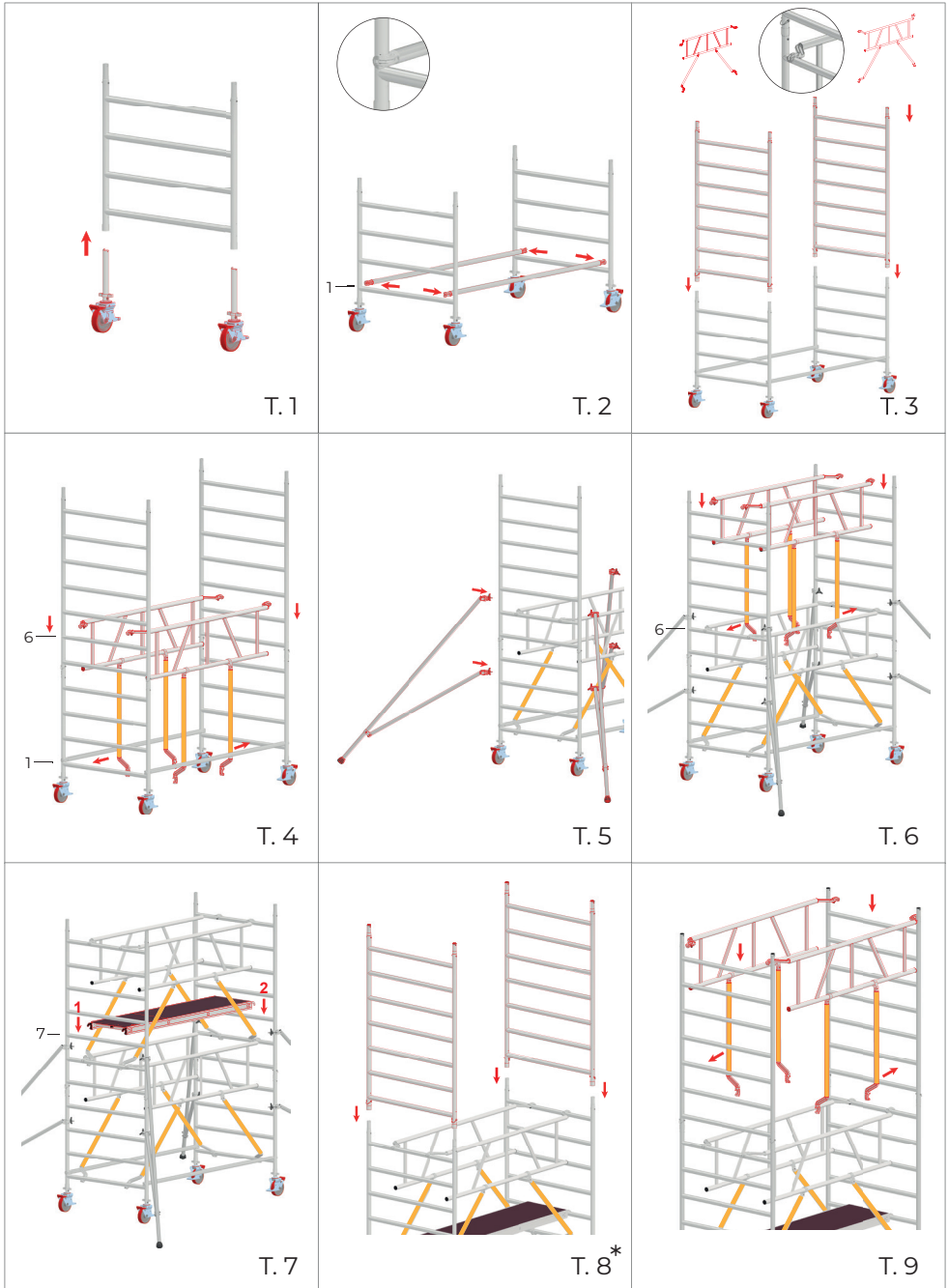

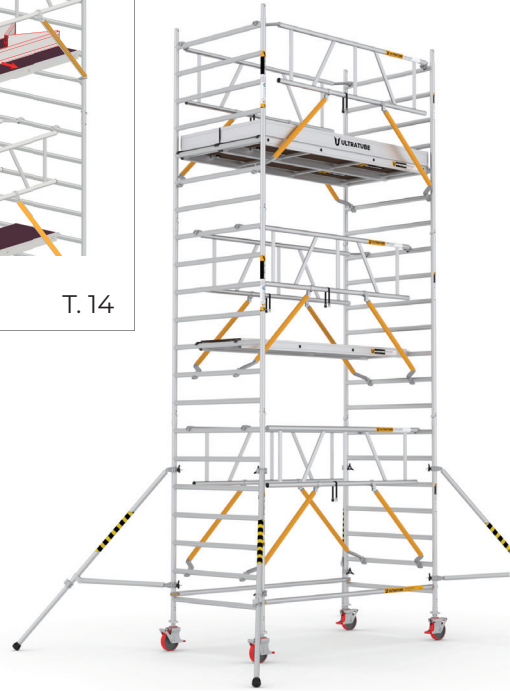
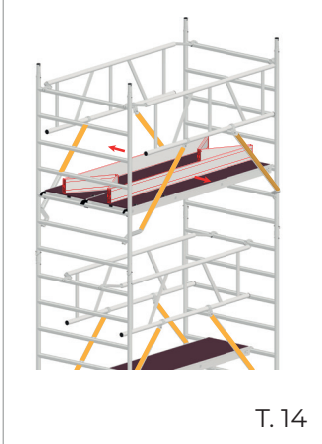
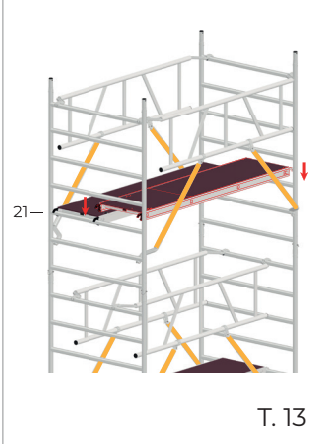
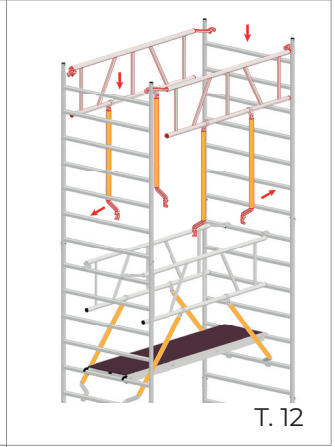
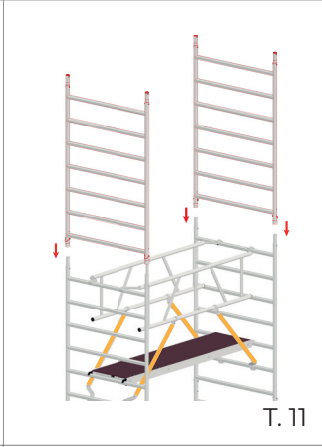
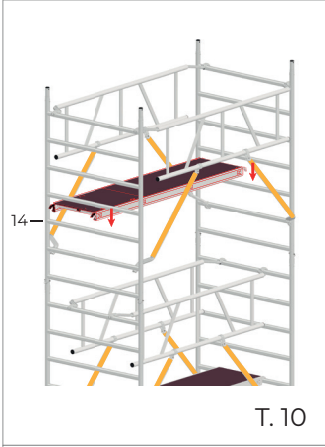

**ULTRATUBE
ULN615 SG_(240)**

* Daha uzun konfigürasyonlar için T8, T9, T10 adımlarını tekrarlayınız.

Repeat steps T8, T9, T10 for higher configurations.

Повторяйте шаги T8, T9, T10 для высшей конфигурации

Répétez les étapes T8, T9, T10 pour une configuration plus haute

Wiederholen Sie die Schritte T8, T9, T10 länger Konfigurationen.

Repita los pasos T8, T9, T10 para mayor configuracion

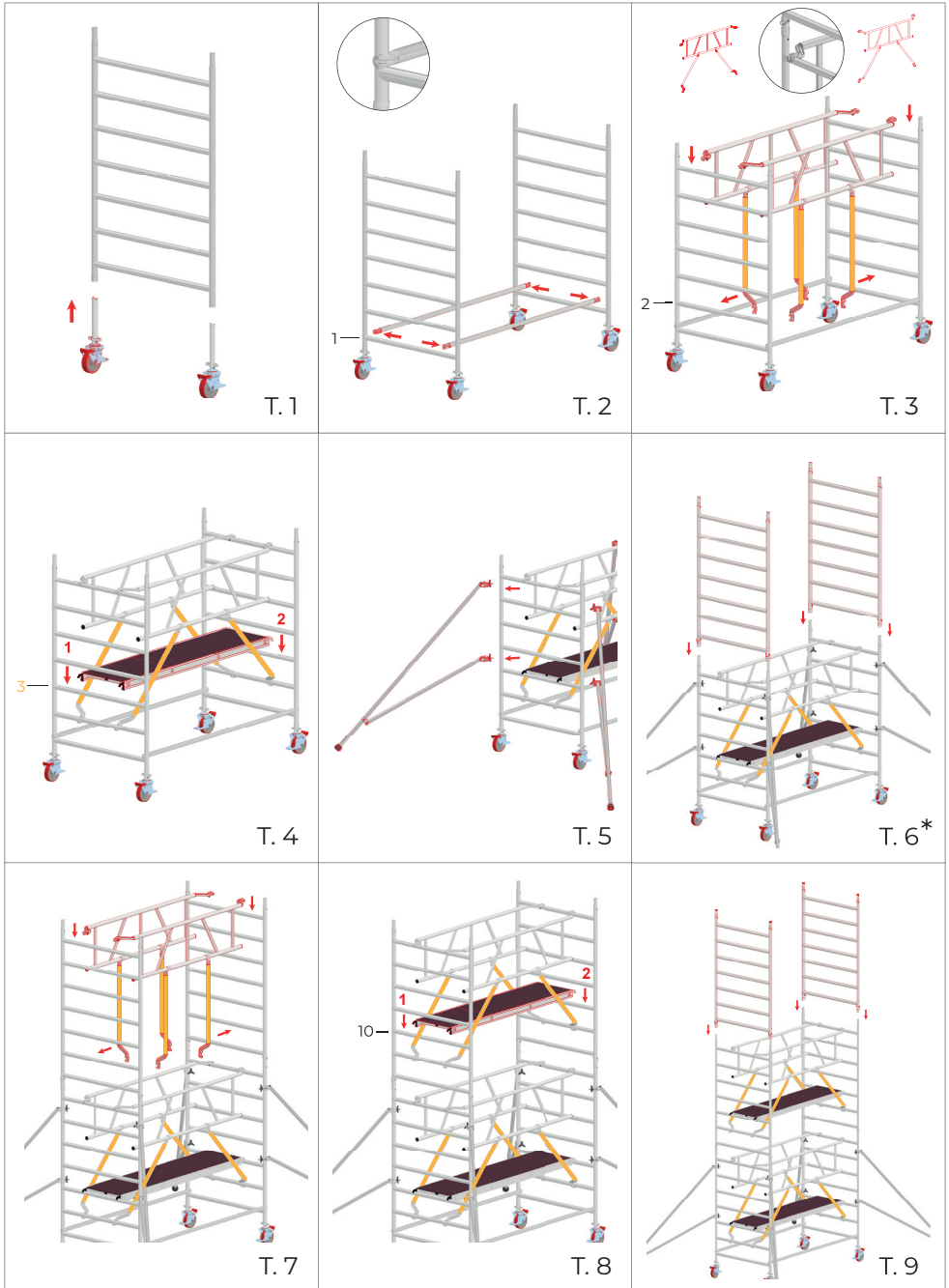

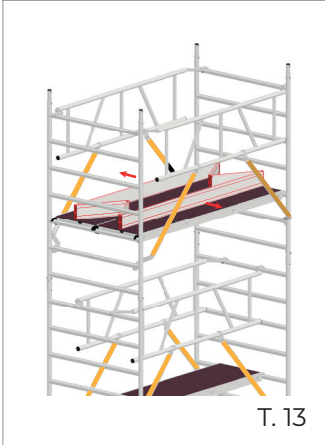
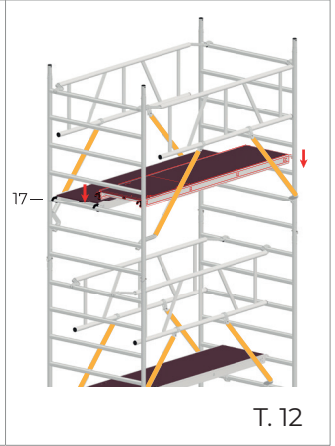
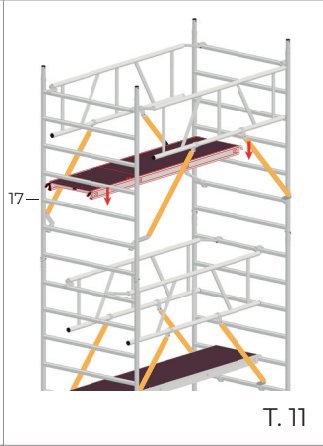
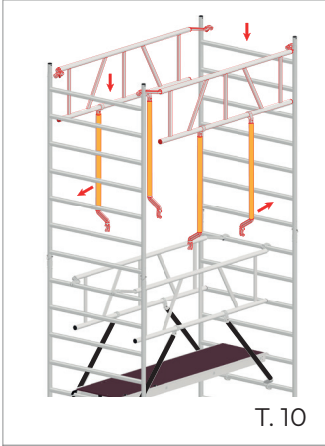

* Daha uzun konfigürasyonlar için T6, T7, T8 adımlarını tekrarlayınız.

Repeat steps T6, T7, T8 for higher configurations.

Повторяйте шаги T6, T7, T8 для высшей конфигурации

Répétez les étapes T6, T7, T8 pour une configuration plus haute

Wiederholen Sie die Schritte T6, T7, T8 länger Konfigurationen.

Repita los pasos T6, T7, T8 para mayor configuracion

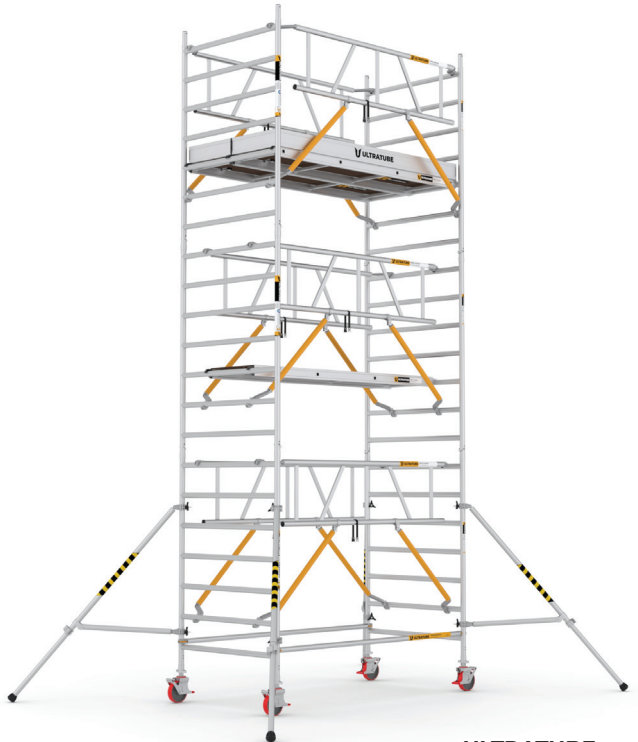

**ULTRATUBE
ULN505_SG(240)**

ULTRATUBE ULN_SG

**1****PT200TE**

TR Tekerlek 200mm
EN Castor 200mm
RU Кастор 200мм
FR Roue 200mm
DE Rolle 200mm
ES Rueda 200mm

**2****UP0113540**

TR 4 Basamaklı çerçeve
EN 4 Rungs frame
RU 4-х ступенчатая рама
FR Cadre à 4 échelons
DE Rahmen mit 4 Sprossen
ES Marco de 4 peldaños

**5****UP0113570**

TR 7 Basamaklı çerçeve
EN 7 Rungs frame
RU 7-х ступенчатая рама
FR Cadre à 7 échelons
DE Rahmen mit 7 Sprossen
ES Marco de 7 peldaños

**6****UP0723000**

TR Payanda
EN Stabiliser
RU Стабилизатор
FR Stabilisateur
DE Stabilisator
ES Estabilizador

ULTRATUBE ULN_SG (300cm)

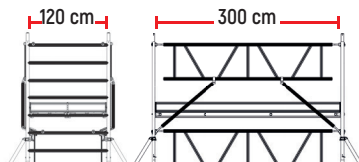

		ULN225 SG_(300)	ULN310 SG_(300)	ULN420 SG_(300)	ULN505 SG_(300)	ULN615 SG_(300)	ULN700 SG_(300)	ULN810 SG_(300)	ULN895 SG_(300)	ULN1000 SG_(300)	ULN1090 SG_(300)	ULN1205 SG_(300)
a		2,2m.	3,1m.	4,2m.	5,0m.	6,1m.	7,0m.	8,1m.	8,9m.	10,0m.	10,9m.	12,0m.
b		4,2m.	5,1m.	6,2m.	7,0m.	8,1m.	9,0m.	10,1m.	10,9m.	12,0m.	12,9m.	14,0m.
kg												
5,7	PT200TE 282x649x125mm. 	4	4	4	4	4	4	4	4	4	4	4
6,2	UP0113540 1350x1327x50mm. 	2	-	2	-	2	-	2	-	2	-	2
1,8	UP0430500 3137x50x50mm. 	2	2	2	2	2	2	2	2	2	2	2
9,8	UP0625000 3138x750x250mm. 	4	4	6	6	8	8	10	10	12	12	14
10,4	UP0113570 1350x2234x50mm. 	2	4	4	6	6	8	8	10	10	12	12
5,7	UP0113570 1800x160x160mm. 	4	4	4	4	4	4	4	4	4	4	4
21,4	UP05305100 2577x600x100mm. 	2	2	3	3	4	4	5	5	6	6	7
10,6	UP1030513500 3030x160x80mm. 	1	1	1	1	1	1	1	1	1	1	1
TOTAL KG		183	191	246	254	309	318	372	381	435	444	499

Hazırlayan: aęsan Merdiven ve Eriřim Ekipmanları San. Tic. Ltd. řti.

©2026 Tm hakları saklıdır. aęsan Merdiven'in yazılı izni olmaksızın bu dokmanın tamamı veya belli bir blm hiębir řekilde basılı veya herhangi dięer bir elektronik ortamda kullanılamaz, oęaltılamaz ve kopyalanamaz.

Prepared by: aęsan Merdiven ve Eriřim Ekipmanları San.Tic.Ltd.řti.

©2026 All rights reserved. Without the written consent of aęsan Merdiven, all or any part of this document may be printed or copied.



Cagsan Merdiven ve Erisim Ekipmanlari San.Tic.Ltd.Sti.

TR: Dilovasi Organize Sanayi Bolgesi 3.Kisim, Meric Cad. No:1 Muallimkoy,
Gebze, Kocaeli/TURKIYE T: +90 262 759 18 08 F: +90 262 759 18 78

EU: Stresemannstr. 123, 10963 Berlin/GERMANY

info@cagsan.com | www.cagsan.com