

ULTRATUBE ULN_SD

EN 1004-1:2020

EN 1004-2:2021



202507-IU-1215

 **ULTRATUBE**

TR	Kullanım Kılavuzu
EN	User Manual
RU	Руководство пользователя
FR	Manuel de l'Utilisateur
DE	Benutzerhandbuch
ES	Manual de usuario

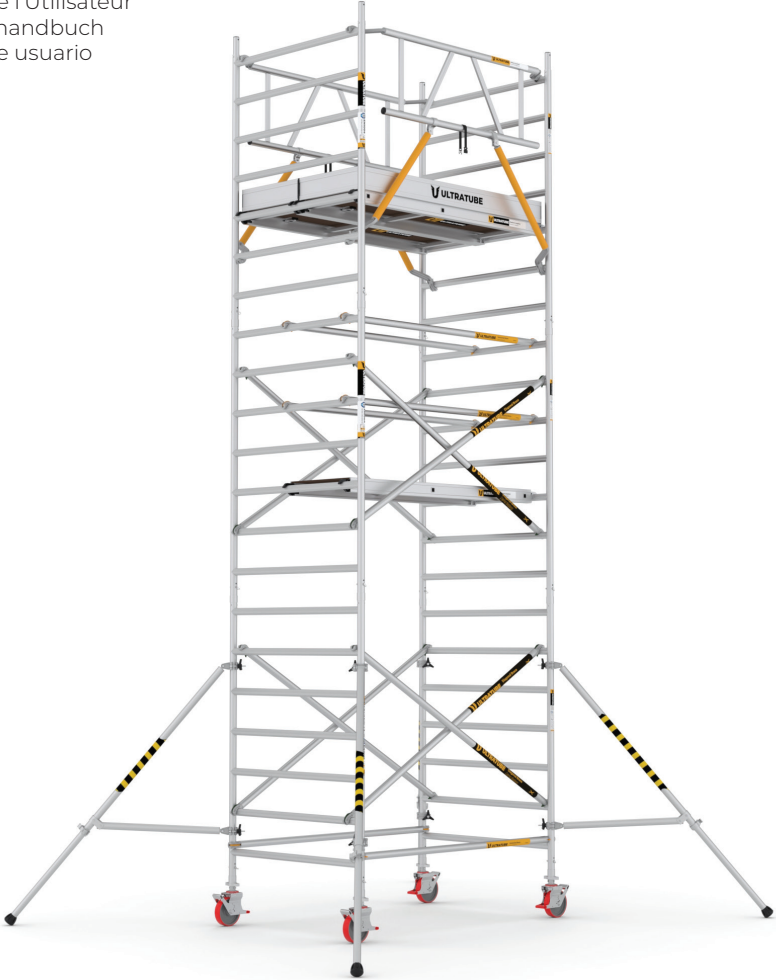

 **CAGSAN**

EN 1004

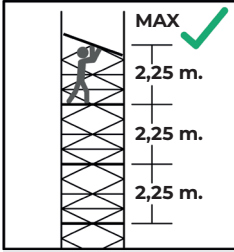

F. 1

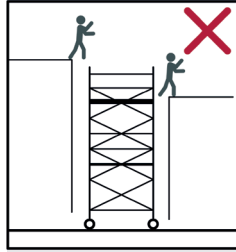

F. 2

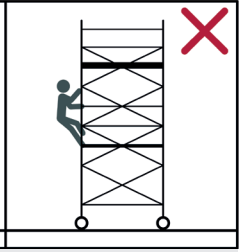
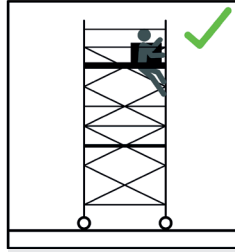

F. 3



F. 4

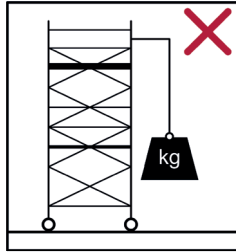

F. 5

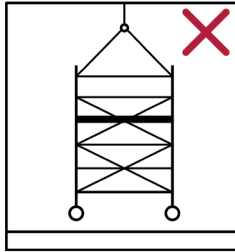

F. 6

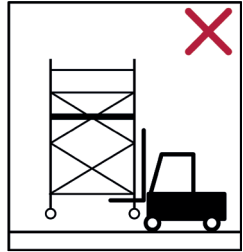

F. 7

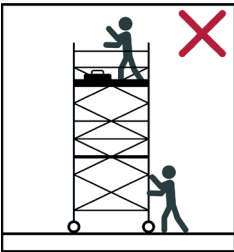

F. 8

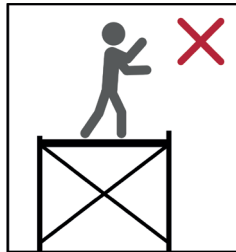

F. 9

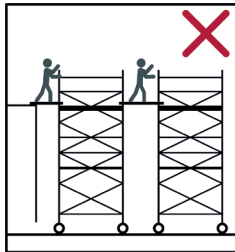

F. 10

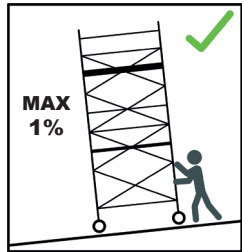

F. 11

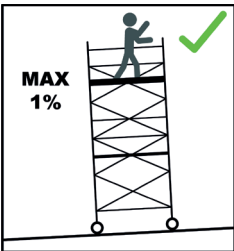

F. 12

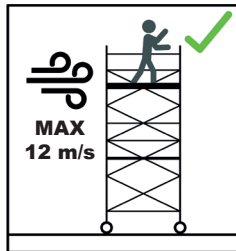

F. 13

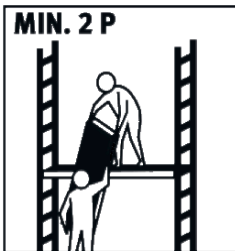

F. 14

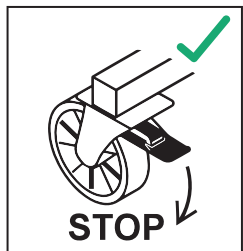

F. 15

EN 1004



F. 14



F. 15



F. 16



F. 17

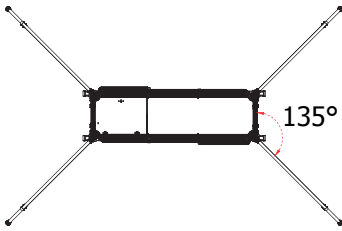

F. 19

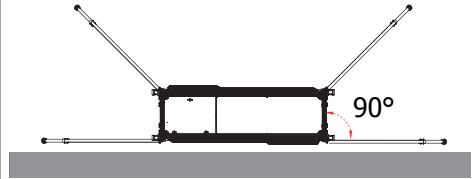

F. 20

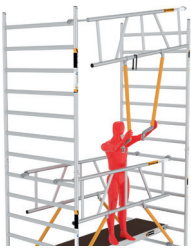

F. 21



F. 22



F. 23



F. 24

(180)

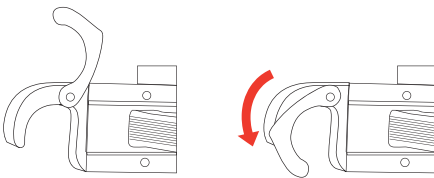

F. 25

(240)

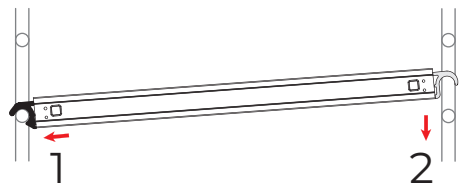

F. 26

ULTRATUBE ULN505_SD(180)

1 PT200TE

2 UP0113570

3 UP0419000

4 UP0419010

5 UP0723000



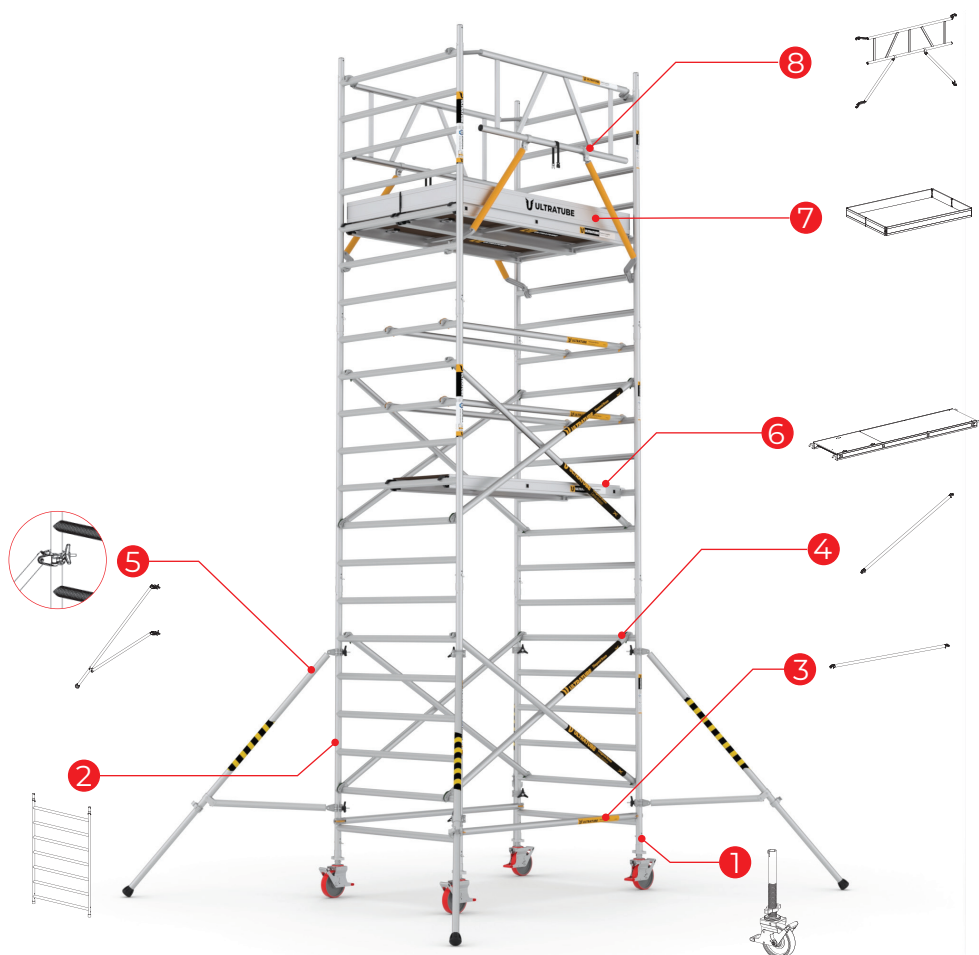

6 UP05190100

7 UP1019013500



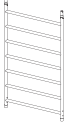

8 UP0619000







ULTRATUBE ULN_SD

			
PT200TE	UP0113540	UP0113570	UP0723000
TR Tekerlek 200mm EN Castor 200mm RU Кастор 200mm FR Roue 200mm DE Rolle 200mm ES Rueda 200mm	TR 4 Basamaklı çerçeve EN 4 Rungs frame RU 4-х ступенчатая рама FR Cadre à 4 échelons DE Rahmen mit 4 Sprossen ES Marco de 4 peldaños	TR 7 Basamaklı çerçeve EN 7 Rungs frame RU 7-х ступенчатая рама FR Cadre à 7 échelons DE Rahmen mit 7 Sprossen ES Marco de 7 peldaños	TR Payanda EN Stabiliser RU Стабилизатор FR Stabilisateur DE Stabilisator ES Estabilizador





ULTRATUBE ULN_SD_(180)

			
UP0419000	UP0419010	UP05190100	UP1019013500 <small>(PT240TM)</small>
TR Yatay bağlantı EN Horizontal braces RU Горизонтальные распорки FR Croisillon Horizontaux DE Horizontale Klammern ES Tirantes horizontales	TR Çapraz bağlantı EN Diagonal Braces RU Диагональные скобки FR Bretelles diagonales DE Diagonale Klammern ES Tirantes diagonales	TR Platform EN Platform RU Платформа FR Plate-forme DE Plattform ES Plataforma	TR Tekmelik EN Toeboard RU Бортик FR Plinthe DE Fußbrett ES Rodapié
			
UP0619000			
TR Güvenli Korkuluk EN Safe Guardrail RU Ограждение безопасности FR Garde-corps sûr DE Sichere Leitplanke ES Barandilla de seguridad			

ULTRATUBE ULN_SD_(240cm)

 <p>UP0625000</p> <p>TR Yatay bağlantı EN Horizontal braces RU Горизонтальные распорки FR Croisillon Horizontaux DE Horizontale Klammern ES Tirantes horizontales</p>	 <p>UP0425010</p> <p>TR Çapraz bağlantı EN Diagonal Braces RU Диагональные скобки FR Bretelles diagonales DE Diagonale Klammern ES Tirantes diagonales</p>	 <p>UP05250100</p> <p>TR Platform EN Platform RU Платформа FR Plate-forme DE Plattform ES Plataforma</p>	 <p>UP1025013500</p> <p>TR Tekmelik EN Toeboard RU Бортик FR Plinthe DE Fußbrett ES Rodapié</p>
 <p>UP0619000</p> <p>TR Güvenli Korkuluk EN Safe Guardrail RU Ограждение безопасности FR Garde-corps sûr DE Sichere Leitplanke ES Barandilla de seguridad</p>			

ULTRATUBE ULN_SD_(300cm)

 <p>UP0430500</p> <p>TR Yatay bağlantı EN Horizontal braces RU Горизонтальные распорки FR Croisillon Horizontaux DE Horizontale Klammern ES Tirantes horizontales</p>	 <p>UP0430510</p> <p>TR Çapraz bağlantı EN Diagonal Braces RU Диагональные скобки FR Bretelles diagonales DE Diagonale Klammern ES Tirantes diagonales</p>	 <p>UP05305100</p> <p>TR Platform EN Platform RU Платформа FR Plate-forme DE Plattform ES Plataforma</p>	 <p>UP1030513500</p> <p>TR Tekmelik EN Toeboard RU Бортик FR Plinthe DE Fußbrett ES Rodapié</p>
 <p>UP0630500</p> <p>TR Güvenli Korkuluk EN Safe Guardrail RU Ограждение безопасности FR Garde-corps sûr DE Sichere Leitplanke ES Barandilla de seguridad</p>			

ULTRATUBE ULN_SD (180cm)

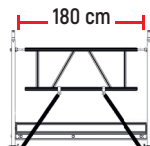

		ULN225 SD_(180)	ULN310 SD_(180)	ULN420 SD_(180)	ULN505 SD_(180)	ULN615 SD_(180)	ULN700 SD_(180)	ULN810 SD_(180)	ULN895 SD_(180)	ULN1000 SD_(180)	ULN1090 SD_(180)	ULN1205 SD_(180)
a		2,2m.	3,1m.	4,2m.	5,0m.	6,1m.	7,0m.	8,1m.	8,9m.	10,0m.	10,9m.	12,0m.
b		4,2m.	5,1m.	6,2m.	7,0m.	8,1m.	9,0m.	10,1m.	10,9m.	12,0m.	12,9m.	14,0m.
kg 5,7	PT200TE 282x638x108mm. 	4	4	4	4	4	4	4	4	4	4	4
6,2	UP0113540 1340x1245x51mm. 	2	-	2	-	2	-	2	-	2	-	2
1,8	UP0419000 1999x50x50mm. 	2	2	6	6	10	10	14	14	18	18	22
2,0	UP0419010 2304x50x50mm. 	4	4	8	8	12	12	16	16	20	20	24
7,2	UP0619000 1998x750x250mm. 	2	2	2	2	2	2	2	2	2	2	2
10,4	UP0113570 1340x2085x51mm. 	2	4	4	6	6	8	8	10	10	12	12
5,7	UP0723000 1800x160x160mm. 	4	4	4	4	4	4	4	4	4	4	4
17,2	UP05190100 1986x600x100mm. 	2	2	3	3	4	4	5	5	6	6	7
9,2	UP1019013500 1886x160x80mm. 	1	1	1	1	1	1	1	1	1	1	1
TOTAL KG		149	157	203	211	256	264	310	318	363	371	416

ULTRATUBE ULN_SD (240cm)

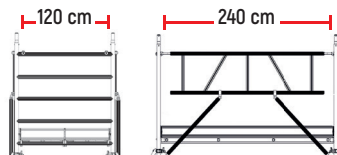

			ULN225 SD_(240)	ULN310 SD_(240)	ULN420 SD_(240)	ULN505 SD_(240)	ULN615 SD_(240)	ULN700 SD_(240)	ULN810 SD_(240)	ULN895 SD_(240)	ULN1000 SD_(240)	ULN1090 SD_(240)	ULN1205 SD_(240)	
a			2,2m.	3,1m.	4,2m.	5,0m.	6,1m.	7,0m.	8,1m.	8,9m.	10,0m.	10,9m.	12,0m.	
b			4,2m.	5,1m.	6,2m.	7,0m.	8,1m.	9,0m.	10,1m.	10,9m.	12,0m.	12,9m.	14,0m.	
kg 5,7	PT200TE 282x638x108mm.		4	4	4	4	4	4	4	4	4	4	4	
6,2	UP0113540 1340x1245x51mm.		2	-	2	-	2	-	2	-	2	-	2	
2,2	UP0425000 2588x50x50mm.		2	2	6	6	10	10	14	14	18	18	22	
2,3	UP0425010 2829x50x50mm.		4	4	8	8	12	12	16	16	20	20	24	
8,4	UP0625000 2588x750x250mm.		2	2	2	2	2	2	2	2	2	2	2	
10,4	UP0113570 1340x2085x51mm.		2	4	4	6	6	8	8	10	10	12	12	
5,7	UP0723000 1800x160x160mm.		4	4	4	4	4	4	4	4	4	4	4	
21,4	UP05250100 2577x600x100mm.		2	2	3	3	4	4	5	5	6	6	7	
10,6	UP1025013500 2479x160x80mm.		1	1	1	1	1	1	1	1	1	1	1	
TOTAL KG			163	171	223	232	284	292	344	352	404	412	464	

ULTRATUBE ULN_SD (300cm)

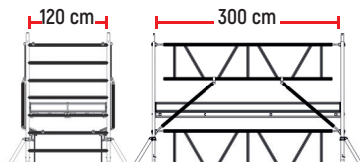

			ULN225	ULN310	ULN420	ULN505	ULN615	ULN700	ULN810	ULN895	ULN1000	ULN1090	ULN1205
			SD_(300)	SD_(300)	SD_(300)	SD_(300)	SD_(300)	SD_(300)	SD_(300)	SD_(300)	SD_(300)	SD_(300)	SD_(300)
a			2,2m.	3,1m.	4,2m.	5,0m.	6,1m.	7,0m.	8,1m.	8,9m.	10,0m.	10,9m.	12,0m.
b			4,2m.	5,1m.	6,2m.	7,0m.	8,1m.	9,0m.	10,1m.	10,9m.	12,0m.	12,9m.	14,0m.
kg 5,7	PT200TE 282x638x108mm.		4	4	4	4	4	4	4	4	4	4	4
6,2	UP0113540 1340x1245x51mm.		2	-	2	-	2	-	2	-	2	-	2
2,6	UP0430500 3137x50x50mm.		2	2	6	6	10	10	14	14	18	18	22
2,7	UP0430510 3338x50x50mm.		4	4	8	8	12	12	16	16	20	20	24
9,8	UP0630500 3138x750x250mm.		2	2	2	2	2	2	2	2	2	2	2
10,4	UP0113570 1340x2085x51mm.		2	4	4	6	6	8	8	10	10	12	12
5,7	UP0723000 1800x160x160mm.		4	4	4	4	4	4	4	4	4	4	4
22,6	UP05305100 2577x600x100mm.		2	2	3	3	4	4	5	5	6	6	7
14,0	UP1030513500 3126x160x80mm.		1	1	1	1	1	1	1	1	1	1	1
TOTAL KG			174	183	239	247	304	312	369	377	434	442	499

ULTRATUBE ULN_SD

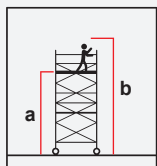

ULN225 ULN420 ULN615 ULN810 ULN1000 ULN1205

a 2,2m. 4,2m. 6,1m. 8,1m. 10,0m. 12,0m.

b 4,2m. 6,2m. 8,1m. 10,1m. 12,0m. 14,0m.

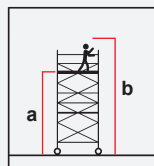

ULN310 ULN505 ULN700 ULN895 ULN1090

a 3,1m. 5,0m. 7,0m. 8,9m. 10,9m.

b 5,1m. 7,0m. 9,0m. 10,9m. 12,9m.



ULTRATUBE USN UP0723000

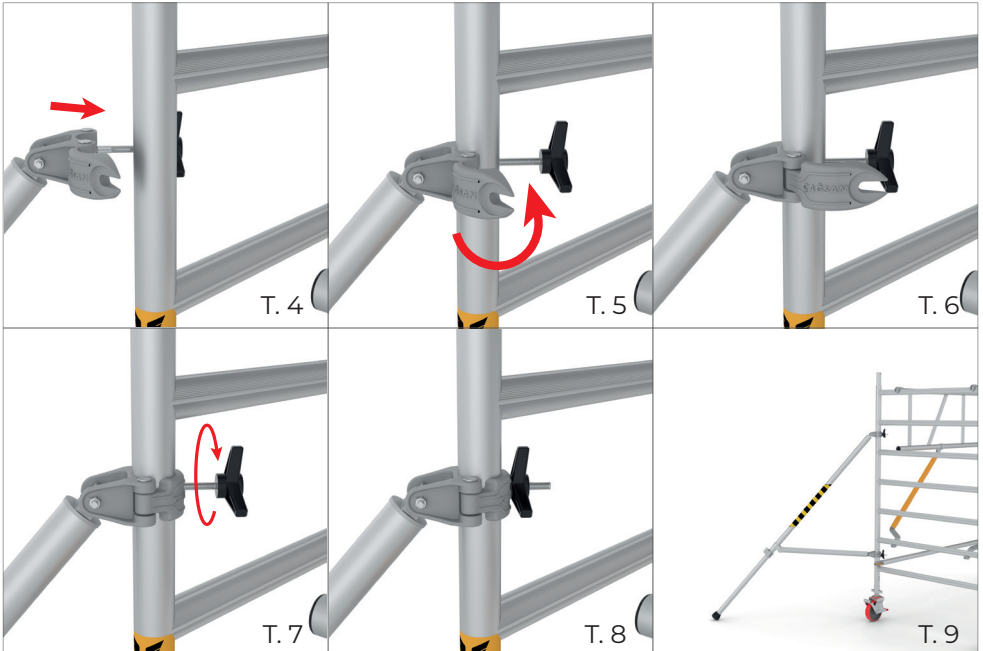

ULTRATUBE ULN_SD

ULN700 SD_(240)

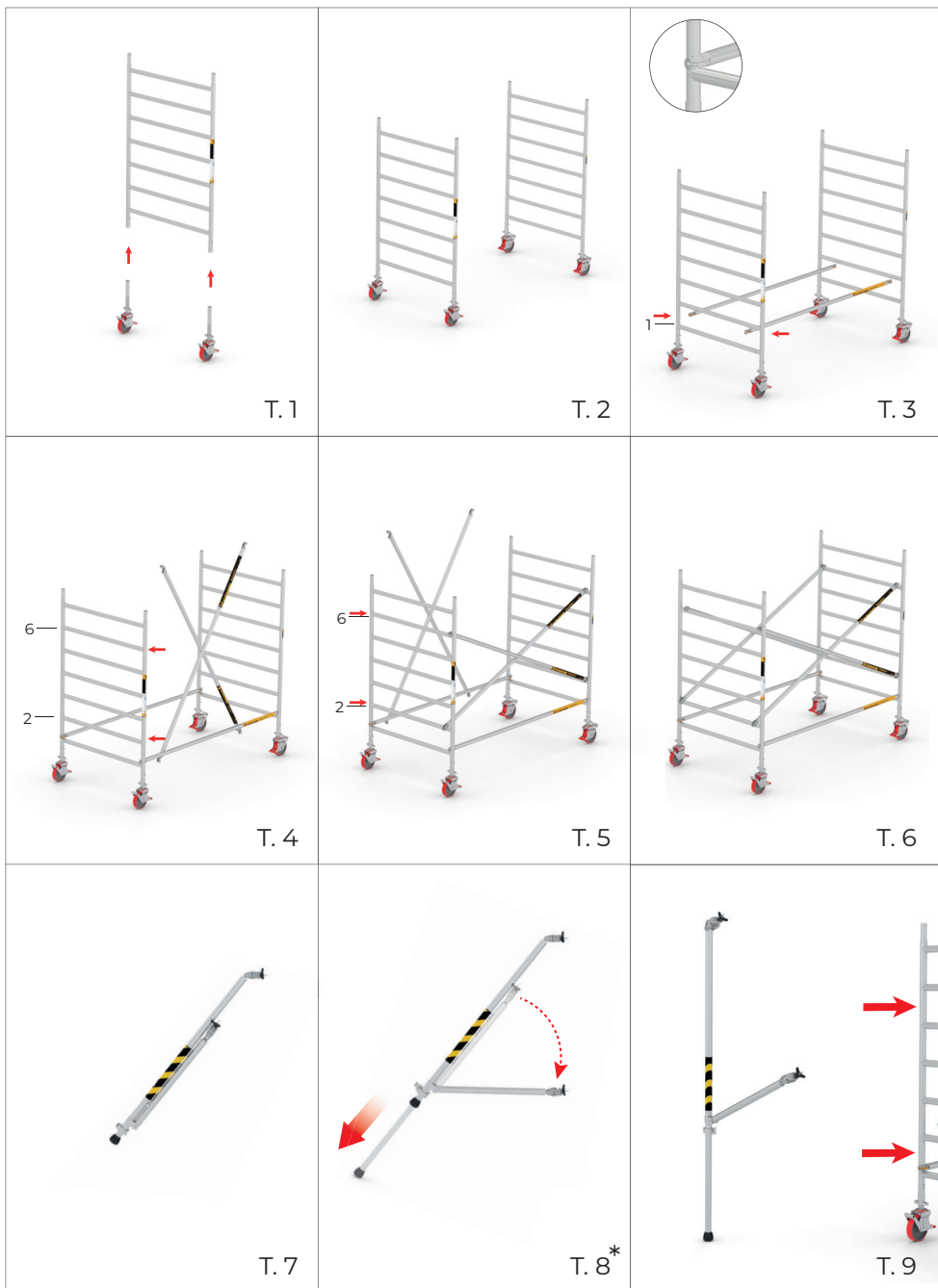

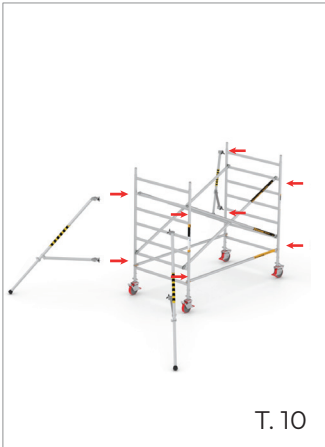

T. 10



T. 11

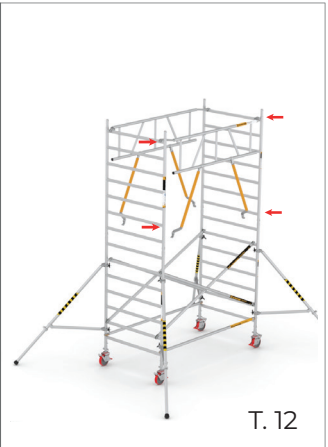

T. 12

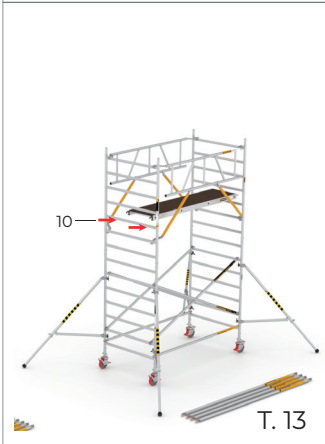

T. 13



T. 14



T. 15



T. 16

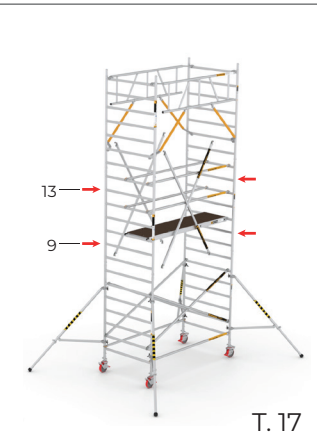

T. 17



T. 18



T. 19

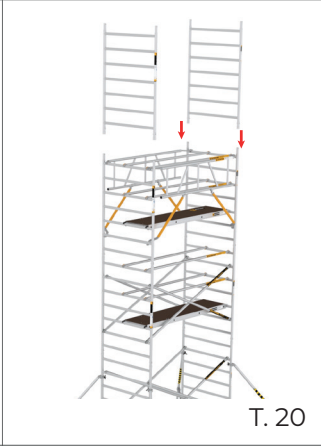

T. 20

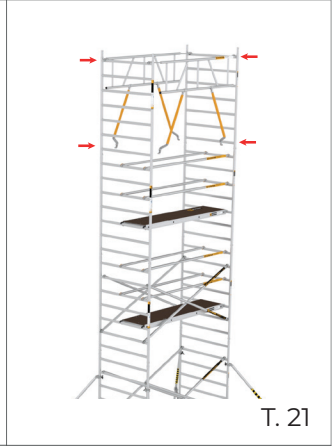

T. 21

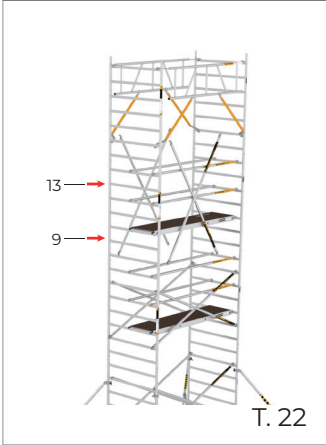

T. 22

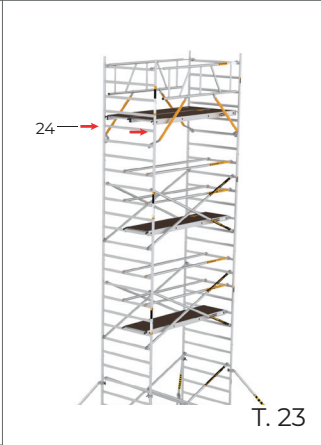

T. 23

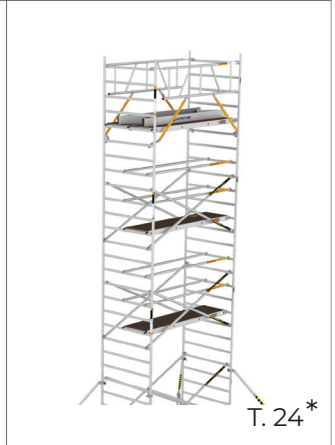

T. 24*



T. 25

*Daha uzun konfigürasyonlar için
T14, T15, T16, T17, T18 adımlarını tekrarlayınız.

Repeat steps T14, T15, T16, T17, T18 for higher
configurations.

Повторяйте шаги T14, T15, T16, T17, T18
для высшей конфигурации

Répétez les étapes T14, T15, T16, T17, T18 pour
une configuration plus haute

Wiederholen Sie die Schritte
T14, T15, T16, T17, T18 länger Konfigurationen.

Repita los pasos T14, T15, T16, T17, T18
para mayor configuracion

**ULTRATUBE
ULN700 SD_(240)**

ULTRATUBE ULN_SG



ULTRATUBE
ULN700 SD_(240)

Hazırlayan: Çağsan Merdiven ve Eriřim Ekipmanları San. Tic. Ltd. Őti.

©2026 Tüm hakları saklıdır. Çağsan Merdiven'in yazılı izni olmaksızın bu dokümanın tamamı veya belli bir bölümü hiçbir şekilde basılı veya herhangi diğeri bir elektronik ortamda kullanılamaz, çoğaltılamaz ve kopyalanamaz.

Prepared by: Çağsan Merdiven ve Eriřim Ekipmanları San.Tic.Ltd.Őti.

©2026 All rights reserved. Without the written consent of Çağsan Merdiven, all or any part of this document may be printed or copied.



Cagsan Merdiven ve Erisim Ekipmanlari San.Tic.Ltd.Sti.

TR: Dilovasi Organize Sanayi Bolgesi 3.Kisim, Meric Cad. No:1 Muallimkoy,
Gebze, Kocaeli/TURKIYE T: +90 262 759 18 08 F: +90 262 759 18 78

EU: Stresemannstr. 123, 10963 Berlin/GERMANY

info@cagsan.com | www.cagsan.com