

90.16

Upright

SPAN 400 LADDER FRAME GUIDE TO ASSEMBLY AND USE

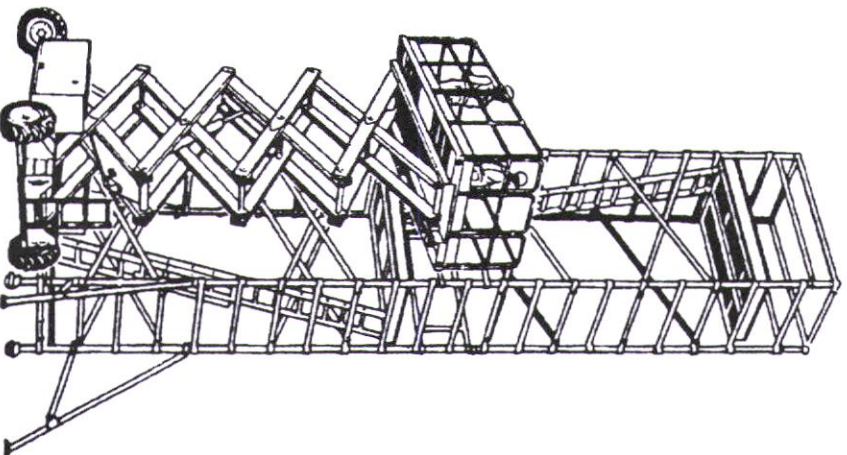

Upright

Upright UK Limited

Access House, Halesfield 17

Telford, Shropshire. TF7 4PW

Tel: 01952 685200

Fax: 01952 685255

e-mail: access@upright.co.uk

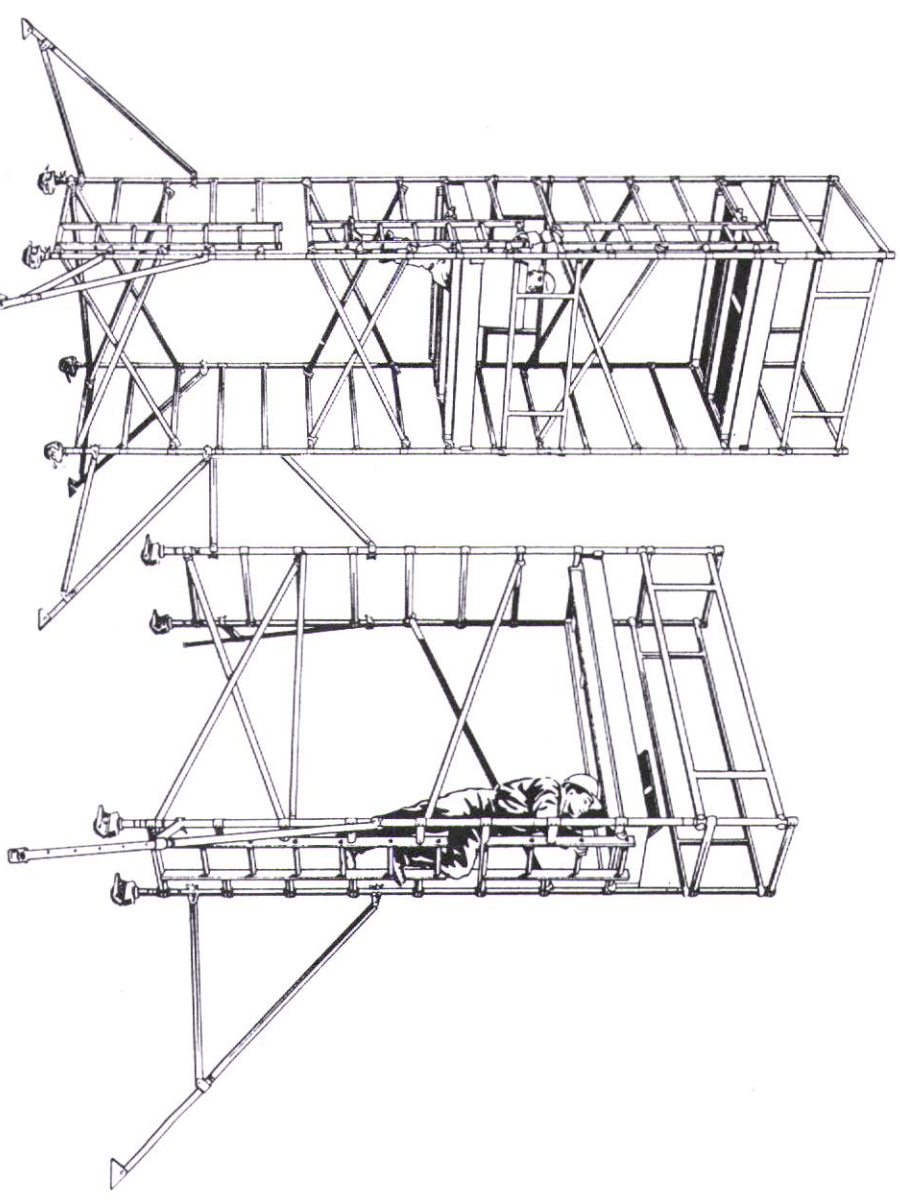

SPAN 400 Ladderframe DW & SW: HD1004 - 3 - 8/12

MOBILE ACCESS AND WORKING TOWERS ACCORDING TO

HD 1004:1992 (BS1139 PART 3:1994)

ALLOWABLE LOADING 2KN/M² (LOAD CLASS 3)

= 360KG (800lb) EVENLY DISTRIBUTED AT ANY PLATFORM LEVEL

TOTAL MAX LOAD PER TOWER MUST NOT EXCEED 720KG (1600lb)

- A MAXIMUM OF TWO PLATFORM LEVELS CAN BE LOADED

WARNING NOTE: This manual gives instructions for the correct assembly and safe use of the Instant Span system. The user is responsible for ensuring that the instruction manual is available on location to the operatives erecting and using the tower, and to the person supervising the work. The user shall also ensure that the operatives erecting the tower are qualified or competent to do so.

Supplied by

Upright UK Limited, Access House, Halesfield 17, Telford, Shropshire, TF7 4PW

Tel: 01952 685200 Fax: 01952 685255 email: access@upright.co.uk

Maximum Working Heights for free-standing Span Towers

NOTES

Type	Indoors, not exposed to wind	Outdoors/exposed to wind
Span 400N Single-Width (0.73m) Standard Stabilizer Part No. 50430	8.0m	6.0m
Span 400N Single-Width (0.73m) Large Stabilizer Part No. 9090	8.0m	8.0m
Span 400W Double-Width (1.40m) Standard Stabilizer Part No. 50430	12.0m	8.0m
Span 400W Double-Width (1.40m) Large Stabilizer Part No. 9090	12.0m	8.0m

For tower heights greater than 12m indoors, or 8m outdoors, contact your supplier for guidance

Towers used in location of possible wind exposure

Care must be taken when using towers in locations where the possibility of exposure to wind exists. Usually this means outdoors but you should be aware of possible funnel-effects between or even inside large open ended buildings. Our recommendations are as follows:

- When wind exceeds Beaufort Force 4 (Moderate Breeze, Max. 8m/s) cease using the tower.
- If wind is expected to reach Force 6 (Strong Breeze, 11m/s), tie tower into a rigid structure.
- If winds of Force 8 (Gale, 17m/s) are forecast, dismantle the tower or remove to shelter.

Use the following table to assist in estimating prevailing wind speeds:

Beaufort Force	Description	Local wind effect	Speed m/s	Speed MPH
3	Gentle Breeze	Leaves and small twigs in constant motion, wind extends light flags.	3 - 5	8 - 12
4	Moderate Breeze	Wind raises dust and loose paper. Small branches move.	5 - 8	13 - 18
5	Fresh Breeze	Small trees in leaf begin to sway. Small crested wavelets form on inland waters.	8 - 11	19 - 24
6	Strong Breeze	Large branches in motion. Umbrellas used with some difficulty.	11 - 14	25 - 31
7	Near Gale	Whole trees in motion. Becoming difficult to walk against the wind.	14 - 17	32 - 38
8	Gale	Twigs break off trees. Progress is generally impeded.	17 - 21	39 - 46

NOTE

- Fit Stabilizers or Outriggers to all towers, tie in to fixed points whenever possible.
- Fit Guardrails to all Platforms and Toeboards to all working Platforms. (All platforms in UK)

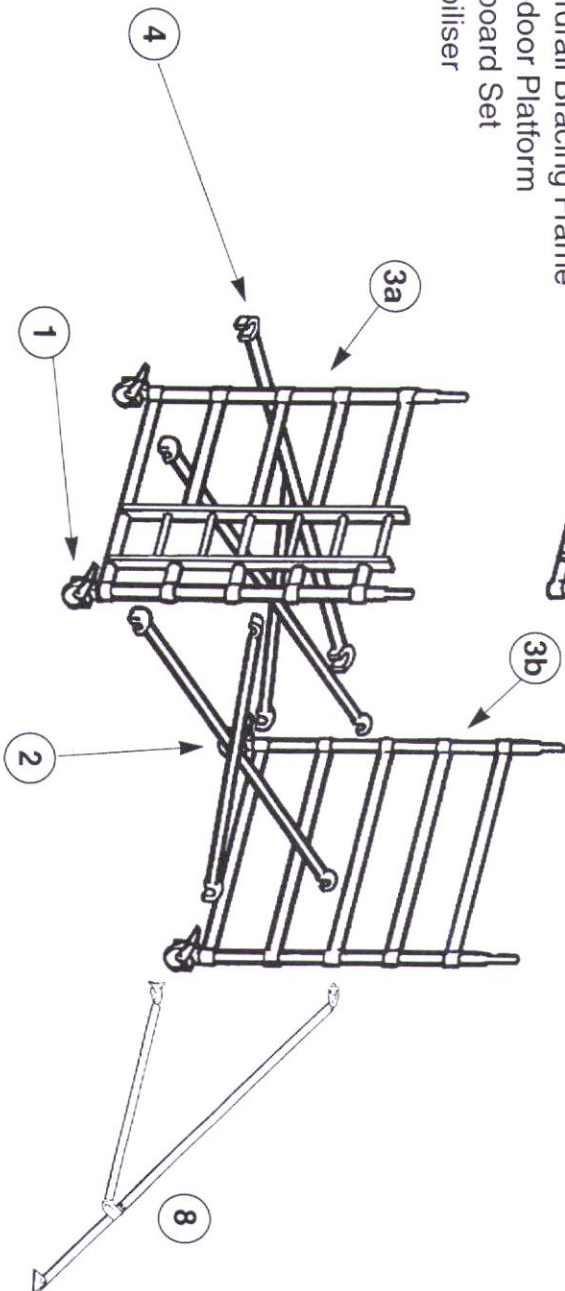
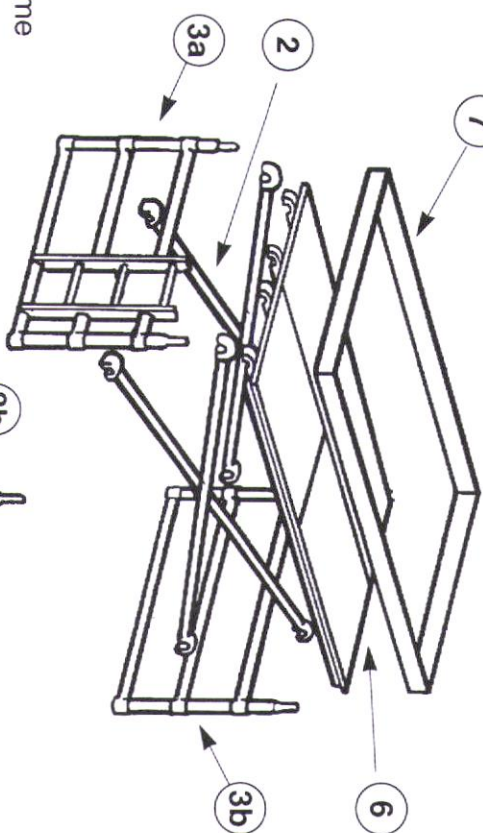
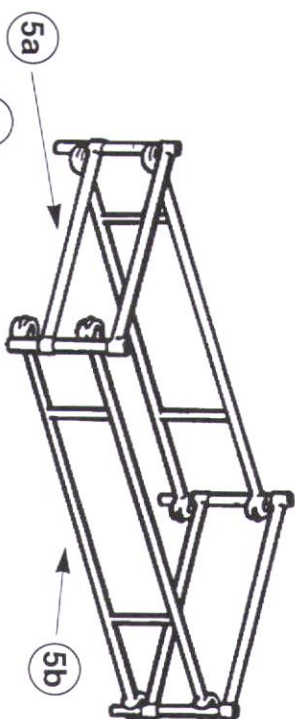

- KEY:**
- 1: Castor
 - 2: Diagonal Brace
 - 3a: End Frame Ladder
 - 3b: End Frame Standard
 - 4: Horizontal Brace
 - 5a: Guardrail Frame
 - 5b: Guardrail Bracing Frame
 - 6: Trapdoor Platform
 - 7: Toeboard Set
 - 8: Stabiliser

Double Width

	Work Height (m)	Tower Height (m)	Platform Height (m)	5.0	6.0	6.0	7.0	8.0	9.0	10.0	11.0	12.0	13.0	14.0
5 Rung Ladder Frame	5.0	4.0	3.0	1	2	3	3	4	4	4	5	6	6	6
5 Rung Standard Frame	4.0	5.0	4.0	1	2	3	3	4	4	4	5	6	6	6
3 Rung Ladder Frame	3.0	4.0	3.0	1	2	3	3	4	4	4	5	6	6	6
3 Rung Standard Frame	-	-	-	1	2	3	3	4	4	4	5	6	6	6
Guardrail Frame	1	1	1	1	2	2	2	2	2	2	2	2	2	2
Guardrail Bracing Frame	2	2	2	2	2	2	2	2	2	2	2	2	2	2
Castor/Baseplate	4	4	4	4	4	4	4	4	4	4	4	4	4	4
Adjustable Leg	4	4	4	4	4	4	4	4	4	4	4	4	4	4
Diagonal Brace	8	8	8	8	8	12	12	16	16	16	20	20	24	24
Horizontal Brace	1	1	1	1	1	1	1	1	1	1	1	1	1	1
Standard Platform	1	1	1	1	1	1	1	1	1	1	1	1	1	1
Trapdoor Platform	1	1	1	1	1	1	1	1	1	1	1	1	1	1
Toeboard Set	1	1	1	1	1	1	1	1	1	1	1	1	1	1
Telescopic Stabilizer	4	4	4	4	4	4	4	4	4	4	4	4	4	4
Heavy Duty Stabilizer	-	-	-	-	-	-	-	-	-	-	-	-	-	-

SPAN 400 LADDERFRAME S/W ASSEMBLY - COMPONENTS

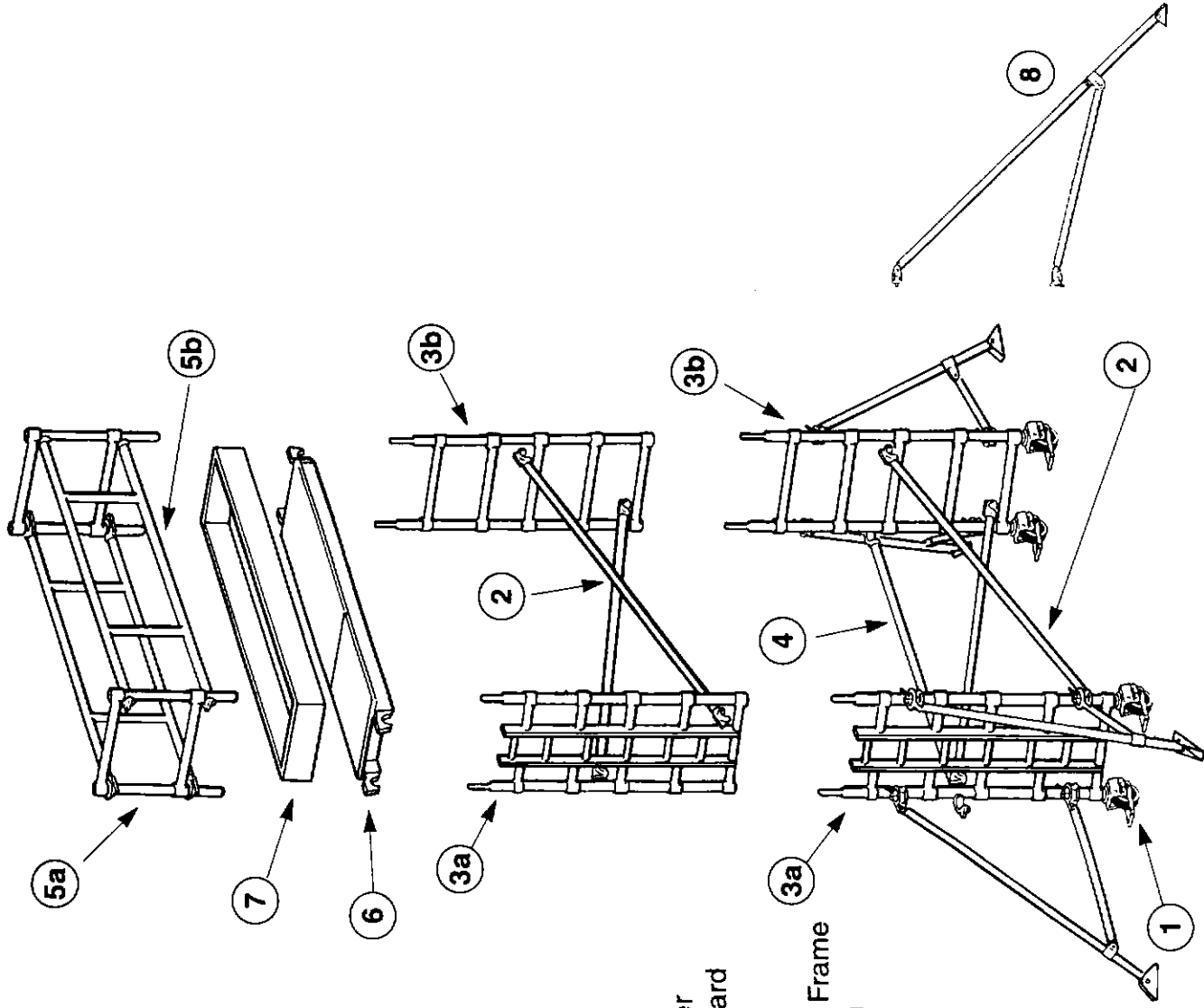

KEY:

- 1: Castor
- 2: Diagonal Brace
- 3a: End Frame Ladder
- 3b: End Frame Standard
- 4: Horizontal Brace
- 5a: Guardrail Frame
- 5b: Guardrail Bracing Frame
- 6: Trapdoor Platform
- 7: Toeboard Set
- 8: Stabiliser

Single Width

Work Height (m)	5.0	6.0	10.0	12.0	14.0
5 Rung Ladder Frame	1	2	3	5	6
5 Rung Standard Frame	1	2	3	5	6
3 Rung Ladder Frame	1	-	-	-	-
3 Rung Standard Frame	1	-	2	2	2
Guardrail Frame	2	2	4	6	6
Guardrail Bracing Frame	4	4	4	4	4
Castor/Baseplate	4	4	4	4	4
Adjustable Leg	4	4	4	4	4
Diagonal Brace	4	4	8	10	12
Horizontal Brace	1	1	1	1	1
Standard Platform	-	-	-	-	-
Trapdoor Platform	1	1	2	3	3
Toeboard Set	1	1	2	3	3
Telescopic Stabilizer	4	4	4	4	4
Heavy Duty Stabilizer	-	-	-	-	4

COMPONENTS REQUIRED

Instant Training

Established in 1988 our dedicated training operation has grown to be one of the UK's leading training organisations. Since our formation more than 35,000 people have been successfully trained.

Instant Training are proud to be accredited with ISO 9001 and can boast to be the first training organisation within the access industry to be awarded this certificate.

To meet the increased demand for training we have developed an extensive portfolio of courses to concentrate on all areas of safety within the work place.

- Instructor Training (Access equipment)
- Operator training courses for mobile powered platforms. IPAF approved
- Tower scaffold training courses
- Safe use of ladders and steps
- Forklift truck/telescopic handler training
- Manual lifting and handling training
- Safety harness training
- Abrasive wheels training
- COSHH training
- Lorry loading training
- Safety awareness/Health & Safety management training
- Fire extinguisher training
- Entry into confined spaces
- Working on roofs

Telephone Instant Training on

01952 585555

Are you complying with your legal requirements ?

It is the responsibility of the employer to ensure all users of aluminium towers have received adequate training.

- Health & Safety at Work Act :1974
- Management of Health & safety at Work Regulations:1992
- Provision & use of work equipment Regulations:1998

Instant Training can ensure you comply with the very latest regulations - we offer a full portfolio of safety training courses including operation of Mobile Elevating Work Platforms. All candidates receive an ID card and certificate of competency whilst the employer complies with relevant regulations.

The courses can be held on-site or at one of our purpose built training centres in Manchester, Leighton Buzzard, Telford and Kent.

Our commitment to creating a safer working world is recognised through the accreditation of ISO9001 and through our team of fully qualified safety instructors.

INSTANT TRAINING

Instant Training
 Access House, Halesfield 17, Telford, Shropshire. TF7 4PW
 Tel : 01952 585555 Fax : 01952 585444
 e-mail : training@upright.co.uk

On Stairs

Use horizontal and diagonal braces as shown. Fit diagonal cross brace on each side of ladder when using single width (Span 400N) components. Use the built in ladder for access.



High Clearance Platform

This component bridges over obstructions at ground level. It should be assembled as follows:



Bring up an end-frame to the High Clearance platform, which can be supported on one diagonal strut. Clip on the platform hooks (locking type) and diagonal strut to the frame. The platform can be supported by this bracing strut while bringing up the second end frame.



Secure platform end and diagonal strut as before, then proceed with normal tower assembly on this base section, ensuring that stabilizers or outriggers are fitted if required. Use one standard and one trap-door platform.

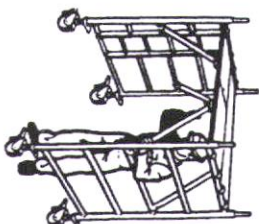

Bridging Beams

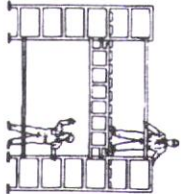

These components can be used to brace and link together single or double width towers, allowing very large clear platform areas to be constructed. These beams can be clipped to frames against any rung, and should be positioned with the hooks to bottom and the plain tube uppermost.

MAINTENANCE INSTRUCTIONS

1. Keep all equipment clean, especially the spigots and sockets where Frames join. Spigots should fit easily into sockets. Lubricate as necessary with light oil.
2. Remove any dirt or paint from threads of Adjustable Legs by light wire brushing. Lightly oil the adjustment levers.
3. If components do not work smoothly, check for any foreign substance, paint, grit, caulking, burrs, etc. and remove.
4. Do not strike the equipment with hammers, crowbars or heavy objects.
5. Keep horizontal cross tubes of end Frames clean where Brace hooks attach, together with the inside surfaces of snap-hooks.
6. The spring-loaded latches of these hooks must be kept clean and lubricated with light oil to activate freely.
7. Keep the upper section Legs and Spigots vertical when inserting or removing them from the sockets of a lower section. Do not damage Spigots or sockets by forcing the Leg back and forth.
8. Handle the equipment carefully - do not throw or drop onto hard surfaces or allow heavy objects to fall onto components. Such abuse may reduce the structural integrity of the equipment.
9. Never use damaged or broken components. Always consult the supplier on any questions regarding proper use and maintenance of the equipment. Repair and replacement parts, assemblies and complete sections are available from the manufacturer. Repairs can often be more successfully and economically handled by Upright's repair department.

Frames:

Different height frames are available to ensure your required tower height can be achieved - adjustable legs should not be used for this purpose. Frames are identified by the number of rungs - a 2 rung frame known as a "Guardrail Frame" is used at the top of all towers.

Legs/Casters/Baseplates

Legs slide into the bottom of the frame uprights and feature a quick-release locking lever which operates on a screw thread. Coarse adjustment is provided by squeezing the lever and moving to the desired position - fine adjustment is achieved by turning the threaded stem only. For safety, the leg is locked automatically and cannot be operated under load.

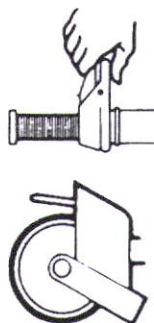

Legs can be fitted with base plates or castors, which slide inside the leg and are retained by a spring-loaded ball bearing. Castors are fitted with brakes which must be applied before using the scaffold.

Interlock Clips

These clips are used to interlock each erected section to the one immediately below. A pin, rivetted to the clip locates into the hole in the frame upright closest to the tee joint and a corresponding hole in the spigot of the interconnecting frame. When dismantling sections, the clip should be transferred to the stowage hole, immediately beside the locating hole.

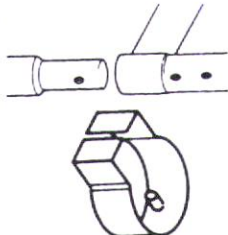

Clip-In Ladders

Purpose-built ladders should always be used and clipped to the structure with the base clear of the ground. Access to platform above is achieved by using a trapdoor platform as shown

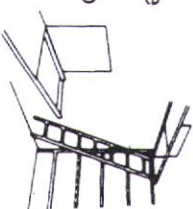

Braces:

There are 2 types of brace: Horizontal or Guardrail and Diagonal. Horizontal braces can be readily identified as they are the same length as the platforms. Diagonal braces are longer. Guardrail braces may be substituted by guardrail bracing frames with integral midrails

Hooks

a) All hooks snap on automatically. To remove, press in the pin or latch and lift clear.
 b) Always check that braces are pushed fully home with pins or latches engaged. Never use force on locking hooks.
 c) The latch-type hook shown is operated by pressing on the thumbcatch, pushing in the direction of the hook.

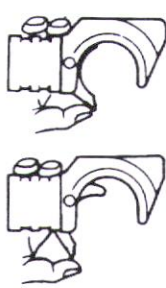

Stabilizers and Outriggers:

These must be fitted to all towers over 2.5m in height, i.e. when more than one 'lift' of frames is used. Stabilizers may be fixed length or telescopic and are fitted with a bearing pad at the base. Outriggers are fitted with castors and can be used when the tower needs to be frequently moved. Castors must be locked before using the tower. Stabilizers and outriggers are normally positioned as Fig. B. When using the tower against a strong wall, they may be positioned as Fig. A, but the wall height must be at least 2/3 of the height of the working platform.

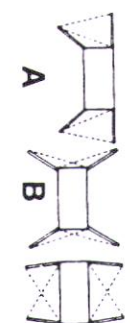
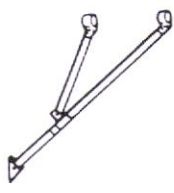

Platform Locking Clips

Platforms are supplied with locking clips to prevent movement in windy conditions. These are fitted to one hook at each end of the platform, and simply clip on to lock. To release, pull back against the spring pressure.

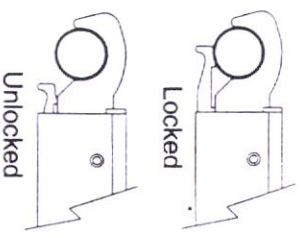

BEFORE ERECTING ANY TOWER

- Ensure that the intended location for the tower is safe and suitable, with respect to the following:
 - a) Ground conditions are firm and level
 - b) Obstructions to erection, moving and safe working
 - c) Wind conditions are acceptable
- Check that all parts, tools and safety equipment (ropes, etc.) needed to erect the tower safely are available at the location of erection.

ASSEMBLY PROCEDURE - DOUBLE WIDTH AND SINGLE WIDTH TOWER

1. Sort the braces into Horizontal and Diagonal. Horizontal are the same length as platforms.

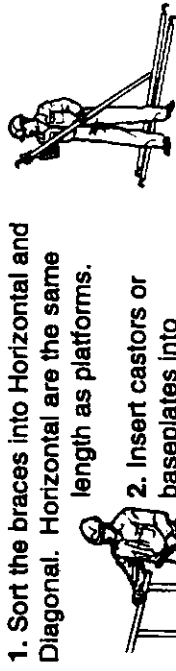

2. Insert castors or baseplates into adjustable legs, and insert legs into the bottom of two of the largest frames. Leave approx. 100mm of thread protruding from the frame.

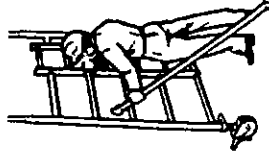

3. Snap one horizontal (guardrail) brace temporarily onto an outside upright of one ladder-type end frame, just above either the first or third cross-tube. Rest the other end on the ground.

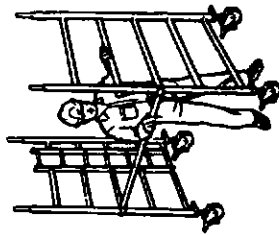

4. Snap the free end of the brace onto a standard-type end frame of the same size in a corresponding position. The frames will now stand upright. **Ensure this brace is in position when dismantling the tower.**

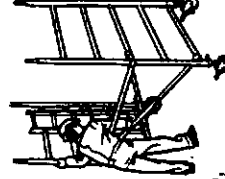

5. Fit two opposing Diagonal braces, each running from the cross tube (rung) of one frame to a cross tube three rungs higher on the other frame. Position both braces close to the uprights on one side of the frame. If using wide (DW) Span, fit an identical pair of braces close to the other upright. **Remember: Narrow (SW) - 2 Diagonals per lift Wide (DW) - 4 Diagonals per lift**

6. This base section must now be checked for level in the location where it will be used. With a spirit level/plumb-bob ensure that uprights are within 1 degree of vertical. Corrections are made using adjustable Legs.

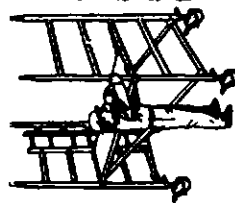

7. Fit a Platform on the Frame rungs, and a guardrail bracing frame to each side of the tower. If no further lifts are to be fitted, go to step 11.

8. If tower is to exceed 2m height, an assistant is required. If the tower height will exceed 2.5m, stabilizers or outriggers must be fitted.

Stabilizers should be attached to each upright of the end frames using the clamps. Prevent upward movement on the upright by locating one of the fittings underneath a tee joint. Ensure that all stabilizer feet are in good contact with firm ground.

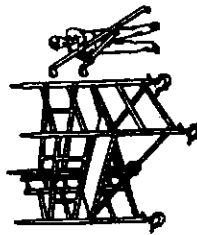

Important: When using Outriggers, fit Outrigger Braces to prevent rotation when in use or being moved.

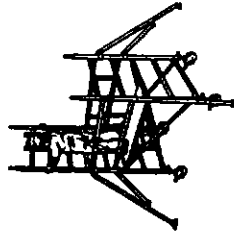

9. Working from the platform, insert end frame extensions of corresponding type to the first lift and fit the interlocking clips. Fit the next set of 4 diagonal braces. (2 for SW, 4 for DW).

10. Position another platform on the upper lift of end frames and fix a guardrail bracing frame on both sides of the tower. Intermediate platforms should be located on the end frame rungs adjacent to the built-in ladder, not obstructing it. Repeat sections 9 & 10 for additional lifts as required: previously positioned platforms and guardrail frames can be moved, but must be spaced at intervals no greater than 4m.

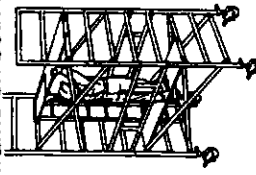

11. After the final lift of extension frames are in place, fit a trapdoor alongside the standard item to give a full width working area. For single width towers fit trapdoor platform only. The platform should be positioned to allow access to the platform from the ladder via the trapdoor. Insert guardrail end frames, securing in position with interlock clips.

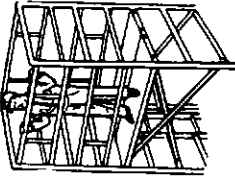

12. Fit another pair of guardrail bracing frames to both sides of the tower at the guardrail level.

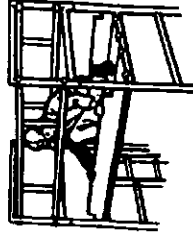

13. Reposition platforms to the correct height positions alongside the ladder. Move surplus guardrail bracing frames to the appropriate intermediate platform levels. Fit toeboards to all working platforms (and in the UK to intermediate platforms) and ensure wind lock clips on platforms are secured.

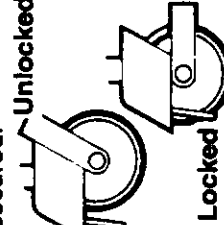

Unlocked 14. Lock castors and ensure that all stabiliser feet are in good contact with firm ground before use.

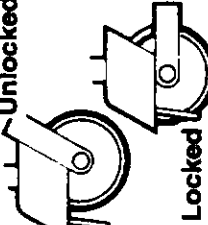

Dismantling: Reverse procedure. Ensure all castors are locked and that the horizontal brace is in position at the foot of the tower as section 4.

NOTE: When using tower against a building or other structure, position the tower so that the access ladder and trapdoor platform are furthest away from the structure.

GENERAL OPERATING RULES

- Engage all Castor brakes before climbing any Instant tower or structure.
- When Moving Tower:
 - Danger!** Watch out for overhead cables and other obstacles.
 - Ensure that all personnel, tools and materials are removed.
 - If Stabilizers are fitted, they must remain in position when moving the tower. Raise by the minimum amount possible to give adequate ground clearance. If this is not possible, dismantle tower to 2.5m height, move and re-assemble.
 - Pull the tower near base, taking care to avoid overturning.
 - After moving, ensure the tower is vertical, the stabilizers correctly positioned and all castors are locked.
 - Ensure that the ground on which a tower is to be moved is capable of supporting the weight of the tower
 - Tower should be moved only by manual effort on ground that is firm, level and free from obstructions. Do not exceed walking speed during relocation of the tower
- The structure must always be level and upright. Make certain that legs are correctly engaged. Do not stretch the platform height with adjustable Legs - these are intended only for levelling. Do not adjust legs with men, tools or materials on any platform.
- Do not lean ladders against any Span structure. Never place ladders or other objects on the platform to gain additional height. Do not push, pull or lean against a wall unless the tower is tied into the building.
- Do not climb or stand on the diagonal braces. Do not jump onto platforms. Work only when standing on the platform inside the structure. When climbing end frames (during erection) always climb inside the structure. Gain access to platforms from ladder by means of trapdoor. Never climb or swing around the outside of any frame.
- Do not use equipment adjacent to live, energised uninsulated electrical apparatus or circuits, or near operating machinery.
- Ensure that Interlocking Clips on tower sections are correctly engaged. Use the "parking hole" to store clips when not in use. Never erect a structure without interlocking the sections. Replace missing or damaged Clips immediately.
- Use only sound, rigid footing or anchorage for the structure. Do not use objects such as barrels, boxes, loose bricks or blocks to support the structure.
- Do not work on any Span tower in winds exceeding Beaufort Force 4. Remove any ice or snow from platforms and if necessary apply grit or salt to prevent slipping. Beware of high winds between buildings. Never move a structure in high winds. Tie-in whenever possible.
- During erection, components should be hoisted by ropes. Do not accumulate tools, materials or debris on platforms.
- Always wear head protection.
- Dilute hydrochloric (muriatic) acid, potash and similar substances corrosive to aluminium can seriously affect the equipment strength. Do not expose aluminium equipment to these materials; consult the manufacturer for special instructions and precautions.
- Do not fit gin wheel or hoist heavy material on the outside of a tower.
- When leaving a tower unattended, tie into a fixed point. Take necessary precautions to prevent unauthorized persons from climbing the tower.
- Place a warning board in a clearly visible location(s) at the base of any incomplete or inoperative tower.
- Never exceed the permitted loading of 2KN/m²; this means 360 kg (800 lb) evenly distributed at any Platform level. The total maximum load per tower must not exceed 720kg (1600 lb) - a maximum of two platform levels can be loaded.

Before each use:

- Check the tower is plumb, level rigid and square. Ensure it is properly erected on solid ground with all necessary safety devices in position, and hooks and spring catches correctly located.
- Ensure Castor brakes are applied.
- Do not use any damaged or incomplete equipment.